

AY2027 Admission Guide
for Department of Creative Informatics
Graduate School of
Information Science and Technology
The University of Tokyo
Examinations Conducted in AY2026

Contact: Department Administration Office

7-3-1 Hongo, Bunkyo-ku, Tokyo 113-8656
University of Tokyo Graduate School of Engineering / Information Science
Office of Academic Affairs Division
Department Team (Department of Creative Informatics)
office@ci.i.u-tokyo.ac.jp

Department's website for Entrance Examinations:

Visit https://www.i.u-tokyo.ac.jp/index_e.shtml

Admissions > Departments and Faculty > Creative Informatics > Admissions

Note 1: In addition to this document, carefully read Admission Guide for Graduate School of Information Science and Technology (read the guide for the applicant's program: Master's program, Doctoral program, or Doctoral program [Special Selection for Professionals]), as well as the Guidelines for Submission of TOEFL Scores.

Note 2: The Department of Creative Informatics conducts Summer entrance examinations and Winter entrance examinations for both the Master's and Doctoral programs. Summer and Winter entrance examinations differ in schedules, examination subjects, and examination methods.

Note 3: Successful applicants may be allowed October 2026 entry for Summer entrance examinations and April 2027 entry for Winter entrance examinations (hereafter referred to as "Early Entrance") if applicants indicate this preference on the application form.

1. Message for applicants

The Department of Creative Informatics is the newest department within the comparatively new Graduate School of Information Science and Technology. It was founded in 2005. The Department of Creative Informatics currently incorporates aspects of five fields: Computer Science, Mathematical Informatics, Information Physics and Computing, Information and Communication Engineering, and Mechano-Informatics. The educational philosophy is “To refine practical creativity for realizing outstanding ideas, through creative practices over interdisciplinary fields.” To achieve this goal, the Department will combine projects and advanced personnel training, and will promote collaborations among industry, government, and academia aimed at human resource cultivation. We hope that students completing this Department's program will play a leading role in the field of information technology.

2. Master’s program

2.1 Examination schedules and examination subjects

i) Summer entrance examination

(1) Document screening

Document screening will be conducted based on the submitted documents. Regarding the notification of the screening, refer to Admission Guide for Graduate School.

(2) General education subjects

Applicants must select either Mathematics or Programming at the time of application.

Those who are absent from the examination in the general education subject are considered to have withdrawn from the entrance examination.

Subject	Date and location	Description
Mathematics	Refer to Admission Guide for Graduate School	
Programming	Thursday, August 20, 2026 (Computer-based test) 10:00 – 12:30, (Interview) 13:00-18:00 School of Engineering; Bldg. No. 6 (tentative) (Details will be posted on the website by the day of the examination)	The basic skills of programming are examined. The applicants must bring their own laptop PCs and write programs for the given topics. They may use their preferred programming languages. The computer-based test has a time limit of 150 minutes. Additionally, a 5-minute interview regarding the computer-based test will be conducted in the afternoon.

Notes: A programming environment must be installed in the laptop PCs used during the programming examination. The applicants may use documents, source programs, libraries, and other resources stored in the PC. Please note that the use of foundational models such as LLM or Copilot is not permitted. Furthermore, Connecting the PC to any network is prohibited during the examination. Confirm that the PC can read from and write to a USB flash drive (type A). The applicants can bring and use a mouse. The applicants can use a two-pronged power outlet.

(3) Foreign language

TOEFL Scores will be used to evaluate the applicants’ English skills. For details, refer to “Guidelines for Submission of TOEFL Scores (for AY2027 Entrance Examinations)”.

(4) Specialized subjects

Applicants shall select one of the following four specialized subjects at the time of application. The applicants not selecting Creative Informatics should find out the details by referring to the Admission Guide for the corresponding department. Those who are absent from the examination in the specialized subjects are considered to have withdrawn from the entrance examination.

Subject	Dates and locations	Description
Creative Informatics	Wednesday, August 26, 2026 13:00 – 15:30 School of Engineering Bldg., No. 6 (tentative) (Details will be posted on the website by the day of the examination)	Applicants solve three problems in the fields related to software and algorithms, computer hardware, information systems, and other related fields. Answering time is 150 minutes.
Computer Science	Refer to Admission Guide for Department of Computer Science.	
Mathematical Informatics	Refer to Admission Guide for Department of Mathematical Informatics.	
Information Physics and Computing	Refer to Admission Guide for Department of Information Physics and Computing.	

(5) Oral examination

The oral examination is conducted in person at Engineering Bldg. No.6 (tentative) on Thursday, August 27, 2026 (when the examination starts and ends depends on the number of applicants). The oral examination schedule will be posted on the website by the day of the examination. In the oral examination, applicants will be asked about the issues such as the written examinations, current research topics, and a research plan at the graduate school.

ii) Winter entrance examination

(1) Document screening

Document screening will be conducted based on the submitted documents. Regarding the notification of the screening, refer to Admission Guide for Graduate School.

(2) General education subject

The applicants must select programming for Winter entrance examination unlike Summer entrance examination. Those who are absent from the examination in the general education subject are considered to have withdrawn from the entrance examination.

Subject	Dates and location	Description
Programming	Friday, January 29, 2027 (Computer-based test)10:00 – 12:30, (Interview) 13:00-18:00 School of Engineering; Bldg. No. 6 (tentative) (Details will be posted on the website by the day of the examination)	Refer to the description for Summer entrance examination.

Note: Refer to the description for Summer entrance examination

(3) Foreign language

TOEFL Scores will be used to evaluate the applicants' English skills. For details, refer to "Guidelines for Submission of TOEFL Scores (for AY2027 Entrance Examinations)".

(4) Specialized subject

Unlike the Summer entrance examination, applicants cannot take examinations for the specialized subjects of other departments. Those who are absent from the written examination are considered to have withdrawn from the entrance exam.

Subject	Dates and location	Description
Creative Informatics	Thursday, January 28, 2027 13:00 – 15:30 School of Engineering, Bldg. No.6 (tentative) (Details will be posted on the website by the day of the examination)	Refer to the description for Summer entrance examination.

(5) Oral examination

The oral examination is conducted in person at Engineering Bldg. No.6 (tentative) on Monday, February 1, 2027 (when the examination starts and ends depends on the number of applicants). The oral examination schedule will be posted on the website by the day of the examination. In the oral examination, applicants will be asked about the issues such as the written examinations, current research topics, and a research plan at the graduate school.

2.2 Submission of Research Plan

Applicants must write a document describing the research field they want to study, the reason for the application, and the research plan after the enrollment on one page of A4-size paper. Applicants also must write a document about their past research activities, and creative activities carried out in university lectures and exercises on one page of A4-size paper. Submit a PDF file containing the two documents together with other application materials. Figures and tables may be included. A list of previously published papers and/or public software, if any, should be included. There is no limit to the number of pages in the list.

3. Doctoral program / Doctoral program [Special Selection for Professionals]

3.1 Examination schedules

i) Summer entrance examination

(1) Document screening

Document screening will be conducted based on the submitted documents. Regarding the notification of the screening, refer to the Entrance Examination Information Page of the department.

(2) Specialized subject and oral examination

Subject	Dates and location	Description
Specialized subject Creative Informatics	Wednesday, August 26, 2026 13:00 – 15:30 School of Engineering Bldg., No. 6 (tentative) (Details will be posted on the website by the day of the examination)	Applicants solve three problems in the fields related to software and algorithms, computer hardware, and information systems, and other related fields. Answering time is 150 minutes.
Oral examination	Friday, August 28, 2026 (When the number of applicants is large, the examination may be also held on Thursday, August 27. When the examination starts and ends depends on the number of applicants.) The oral examination is conducted online. Its schedule will be posted on the website by the day of the examination.	Applicants give a presentation on their Master's thesis or its alternative and doctoral research plans (about 20 min.; slides can be used), and then they are asked questions on the presentation and other issues.

Notes:

(a) TOEFL Scores will be used to evaluate the applicants' English skills. For details, refer to "Guidelines for Submission of TOEFL Scores (for AY2027 Entrance Examinations)".

(b) Applicants are exempted from submitting the TOEFL Scores and taking the examination in specialized subjects if they have graduated or they are expected to complete Master's program at Graduate School of Information Science and Technology, The University of Tokyo.

ii) Winter entrance examination

The examination will be conducted during the period from Thursday, January 28 to Monday, February 1, 2027, excluding Saturday and Sunday. Only a limited number of applicants will be accepted. The examination method will be the same as the method for Summer entrance examination. For the details of the examination in the specialized subject, refer to the corresponding examination for Winter entrance examination for the Master's program.

3.2 Submission documents for the Doctoral program

Summarize your past research achievements and research plans for the Doctoral Program in a report in Japanese or English, comprising no more than six A4-sized pages, and submit it along with other application materials. Figures and tables may be included. A list of previously published papers and/or public software, if any, should be included. There is no limit to the number of pages in the list.

The prospective applicants for the Doctoral program should make close contact with their prospective faculty advisor before the application period. A faculty advisor will be immediately assigned to an applicant (but subject to change) when he/she passes the examination.

3.3 Submission documents for the Doctoral program [Special Selection for Professionals]

In addition to Research Plan written in 3.2, the applicants must submit a one- or two-page A4-size document, which summarizes major achievements during their employment.

The University of Tokyo Graduate School of Information Science and Technology, Department of Creative Informatics

Faculty Advisors and Concurrent Faculty Advisors (as of April 2026)

Select your advisor(s) among the faculty members in this list, and enter your selection (up to ten for master's program, one for doctoral program) through the Web application system.

Faculty Advisors

- Professor Shigeru Chiba
Programming Languages, Software Infrastructure
- Professor Takeo Igarashi
User Interface, Computer Graphics
- Professor Kunihiko Sadakane
Algorithms and Data Structures, Big Data Processing
- Professor Hiroshi Saruwatari
Speech and Acoustic Information Processing, Statistical Signal Processing,
Machine Learning
- Professor Kei Okada
Everyday Life Robotics, Robot System Software
- Professor Hideki Nakayama
Machine Perception, Natural Language Processing, Machine Learning
- Associate Professor Ryota Shioya
Computer Architecture, System Software, Information Security
- Associate Professor Manabu Tsukada
Computer Network, Cyber Physical Systems
- Associate Professor Nobuyuki Umetani
Computer Graphics, Physics Simulation
- Associate Professor Tomoharu Ugawa
System Software, Programming Language, Concurrency, Embedded Systems

Concurrent Faculty Advisors who belong to other departments

- Professor Yusuke Miyao (Dept. of Computer Science)
Natural Language Processing, Computational Linguistics
- Professor Tsuyoshi Takagi (Dept. of Mathematical Informatics)
Mathematical Cryptography, Applied Cryptography
- Professor Kenji Kawashima (Dept. of Information Physics & Computing)
Medical Systems, Human-machine Systems, Robotics, Fluid Measurement and Control
- Professor Kenjiro Taura (Dept. of Information & Communication Engineering)
Parallel and distributed computing, programming languages, big data processing,
high-performance computing, and their applications
- Professor Tatsuya Harada (Dept. of Mechano-Informatics)
Computer Vision, Machine Learning, Real-world Intelligent Information Processing
- Associate Professor Masaki Ito (Social ICT Research Center)
Traffic Informatics, Cyber-physical Systems, Intelligent Transport Systems (ITS),
Human-computer Interaction

COMPUTING SOFTWARE GROUP

also known as Prof. Chiba Shigeru's Group

www.csg.ci.i.u-tokyo.ac.jp



About us

Our research interests are in programming languages and system software, i.e. the *core* of computing systems. We are seeking students who love programming as well as programming language design and software engineering. Our aim is to explore “cool” things related to programming.

To Applicants

We welcome students who have passion and strong interests in software development. Good programming skills are desirable but not mandatory. Only basic programming skills are. Past students were able to quickly learn necessary skills if they like programming. Potential applicants can ask a question about such required skills by emails. Visiting our group is also possible by appointment.

Although writing a toy program is easy, developing truly useful and reliable software with a non-trivial size is not a simple task. It is often just too complex to complete and thus we need to carefully write a program to have a *clear* structure and to be easily readable and maintainable.

Developing software for helping such programming is a main part of our research. Most students are developing software as their art work. Coming up with a good idea, developing software based on that idea, and write a paper is our research activity.

We have been studying and developing program libraries, frameworks, and programming tools for a new style of programming. An example is a library for meta-level programming that automates program translation and generation. It allows user programmers to write a simple program and it automatically rewrites it to have more complex functionalities. Another example is a programming tool for developing a library with a “fluent” programming interface, so called an embedded domain specific language (DSL). Such a kind of DSL is getting important today.

Applying machine learning techniques to programming tools is also our interest. Since we can obtain a large number of real-world programs from public repositories such as GitHub, our challenge is utilizing them as training data. Our study includes analyzing such large number of programs for discovering programming styles in the world and developing a tool for that analysis.

We have been also developing a new programming language, usually an extended version of existing language that supports a new language construct. A language construct is a various component constituting a language, such as a while statement, an object and a class, a lambda expression, type inference, and so forth. As an academic research group, we are working for inventing a new language construct that will be adopted by widely used major programming languages in future.

A wide range of research for helping programming practice is covered. A research topic for an individual student is selected through discussion with a supervisor.

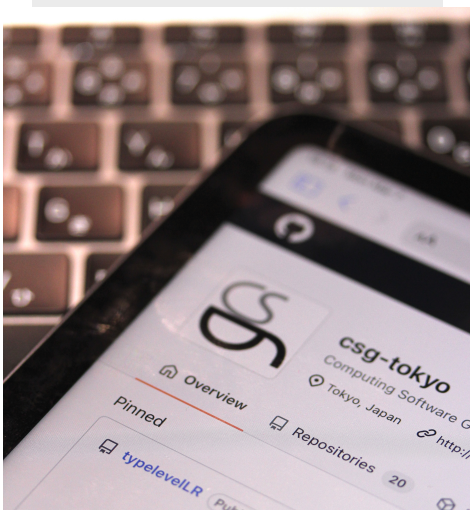

(1) User Interface: We are working on user interfaces for information appliances ranging from personal computers, smartphone, robots, and self-driving automobiles. We not only develop techniques to improve efficiency but also propose new way of interaction or analyzing interactions. Below is some examples.

- User interfaces for machine learning and artificial intelligence. We especially focus on the preparation of training data and interactive learning.
- Interaction techniques for novel appliances such as smartphone, smart watches, AI speakers and smart glasses.
- Interaction techniques for giving directions and controlling real-world systems such as robots and self-driving automobiles.

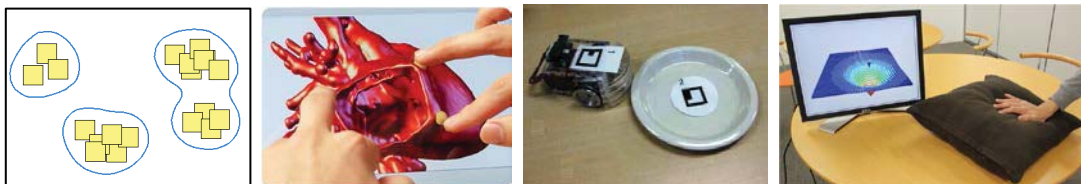

(2) Graphics: We mainly work on interactive shape modeling. We work on content creation for digital media such as movies and games. We also work on interaction techniques for digital fabrication using 3D printers and laser cutters. We focus on techniques for non-expert users.

- Content creation such as 3D modeling and 2D animation using recent technologies such as sketching and machine learning. We also work on interaction techniques for medical imaging.
- Shape modeling for real world objects such as musical instruments, clothes, and toys leveraging real-time physical simulation.
- Novel techniques for 3D scanning and 3D printing to support personal fabrication.

Each student sets his or her own goal in our group, so we expect students to be self-directed and take responsibility. We can provide opportunity for students to collaborate with research groups in other countries and productions.

<http://www-ui.is.s.u-tokyo.ac.jp/>



Name	Prof. Kunihiko Sadakane	Research Field	Algorithms and Data Structures Big Data Processing
------	-------------------------	----------------	---

We work on development of algorithms and data structures for processing big data efficiently. In particular, we work on the following topics.

- Succinct data structure, which can process data in a compressed form without decompression. Not only analyzing algorithms theoretically, but we also implement them and apply them for real data. Possible applications are string databases such as DNA sequences, geographic information such as road networks and movement trajectories.
- Parallel and GPU algorithms for efficiently processing big data.
- Secure computation algorithms which can perform computation on encrypted data for handling private information such as DNA sequences. By combining with the above-mentioned succinct data structures, we develop technologies to process compressed and encrypted data.

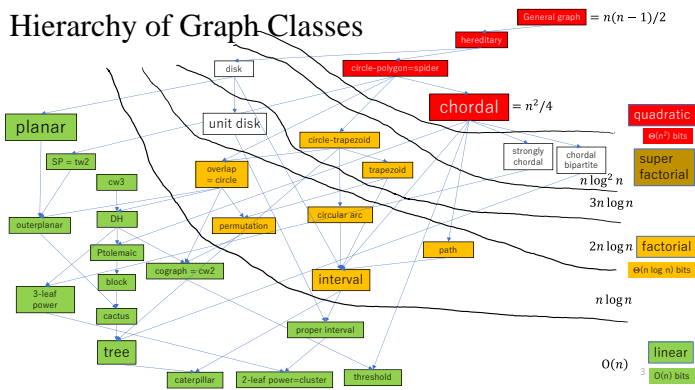

Examples of Succinct Data Structures

- String Indexes
 - Suffix array of 100GB text: 680GB → 22GB
- Genome Assembly
 - Human genome: 300GB → 2.5GB
- Road Network
 - Position information of all roads in Japan: 1.7GB → 170MB

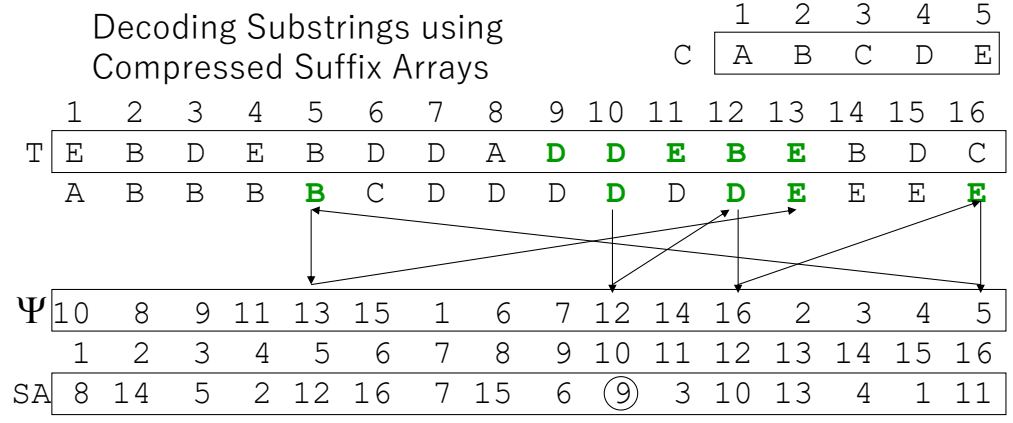
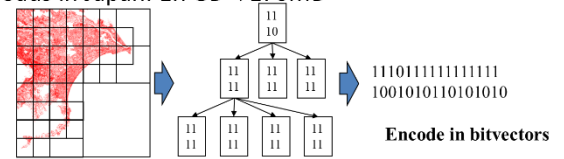
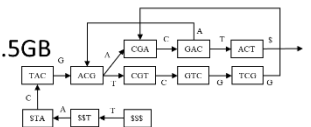

Name	Prof. Hiroshi Saruwatari	Research Field	Acoustic & Statistical Signal Processing, Machine Learning
------	--------------------------	----------------	--

In Saruwatari Laboratory, we mainly address an innovation in new signal processing and information processing systems, focusing our attention on understanding, processing, and control of sound media (speech, music, etc.). For example, theories on new statistical modeling and machine-learning-based algorithms are of interest for us to solve the optimization problems under acoustical generative models and physical constraint. Through the innovation, we realize expansion of human hearing systems, new man-machine interface systems as well as new contribution to music art creation.

Auditory Communication Augmentation Based on Unsupervised/Semi-supervised Learning Systems

We realize versatile unsupervised source separation based on *Independent Low-Rank Matrix Analysis* combining statistical estimation theories and low-rank modeling. Also, we address *Independent Deeply Learned Matrix Analysis* as a new harmony of deep learning and spatial acoustics, which can be applied to semi-supervised source separation. Thanks to these methods, human interface and auditory communication augmentation systems can be developed.



Speech Information Processing Based on Deep Learning

We address theories on signal processing and machine learning for high-quality speech synthesis/conversion as a means of flexible human-human and human-machine communication. We have proposed Generative-Adversarial-Network-based DNN speech synthesis/conversion systems as the world's first attempt and apply them to generation of a complex human voice. Furthermore, by modeling a natural fluctuation in singing voice, we can realize audio virtual reality systems with high expression capability.

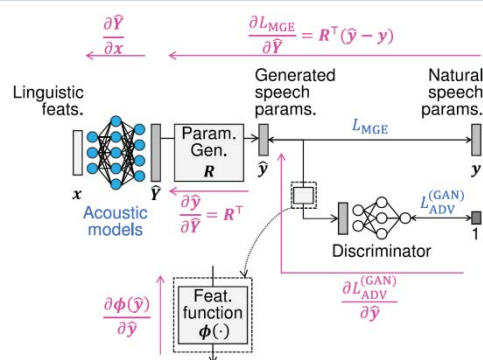

User-Oriented Music Information Processing

We realize high-quality music signal processing systems based on spatio-temporal signal analysis by applying machine-learning algorithms, e.g., nonnegative low-rank approximation and sparse representation to various multidimensional data. Using the systems, we establish versatile user-oriented information processing in order to contribute toward new creation of music art.

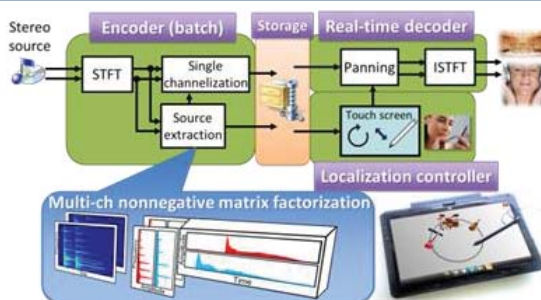

Sound Virtual Reality & Augmented Reality

We create a high-accuracy reproduction theory for complex acoustic fields by introducing the unified mathematical representation of acoustical sound sensing, transmission, transformation, and reproduction. In particular, statistical estimation and super-resolution theories based on spherical harmonic analysis can be introduced to cope with unreliable sensing problems. Finally, we develop an ultra-realistic sound virtual reality system and an augmented reality system that can be applicable to man-machine interaction.



Our laboratory mainly focuses our attention on the theoretical innovation for mathematical modeling of acoustic sounds, and welcomes students who are interested in such a research and big- & small-data processing.

Laboratory: Engineering Bldg. No.6, Hongo Campus WEB: <http://www.sp.ipc.i.u-tokyo.ac.jp/>

1) Everyday Life Robotics

We study robots, especially robots that live with people and support their activities in everyday life environments. We not only pursue a wide range of intelligent robotics fields including control, recognition, inference, search, planning, decision making, and learning, but also integrate these fields and evaluate robots practically through task experiments in the real world and with real robots. We welcome students who are motivated to create robots that they would like to use in the future.



Humanoid robots

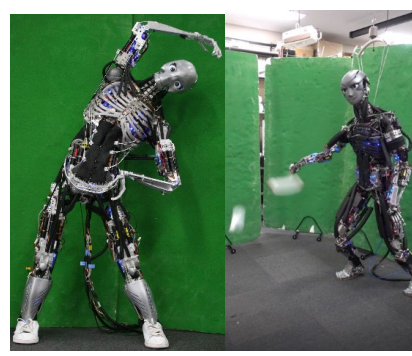

Musculoskeletal robot

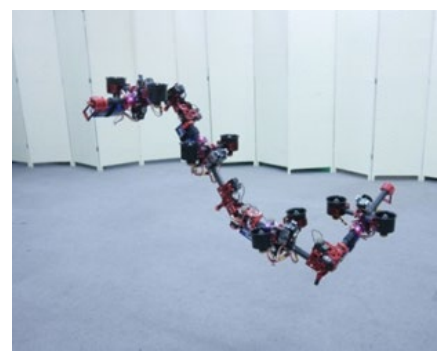

Multi-link flying robot



Robot-robot co-operation



Social robots



Avatar robots

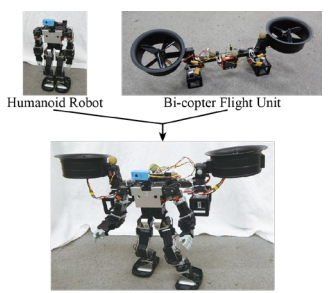

Transform robot

2) Robot System Software

We are conducting research on intelligent robot platform system software. We welcome students who wish to create new information infrastructures for intelligent robotics research, such as programming languages, middleware, system software, and continuous verification development environments for robots.



Open-source robotics

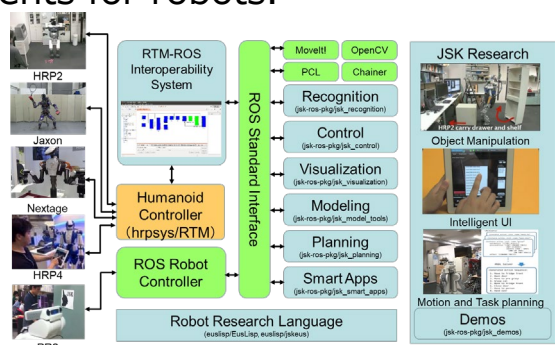

Integrate robot system

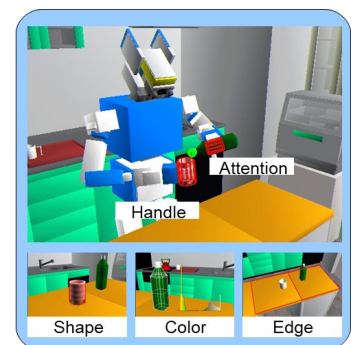

Robot programming language

Some of the robot systems developed in our laboratory can be referenced below.
<https://github.com/EusLisp>, <https://github.com/jsk-ros-pkg>, <https://github.com/start-jsk>

Toward computer systems that learn from big and diverse multimodal data to realize cognitive understanding of the world

Humans can instantaneously understand situations from various sensory information, such as visual and auditory information, and can use language to think, reason, and determine their own actions. While recent advances in machine learning technology, as exemplified by large language models, have led to significant progress in such information processing, much of it is still only superficial and far from human-like.

In Nakayama lab., we are working on both core mathematical methods and applications with the aim of realizing artificial intelligence that is not only more capable than humans, but is also compatible with humans and can be truly trusted in the real world. We are looking forward to the participation of students who are full of enthusiasm and brave ideas.

Multimedia Recognition and Generation

We are mainly focusing on the development of mathematical foundations to realize automatic recognition and understanding of various multimedia such as image, movie, text, speech etc. For example, high-level feature extraction for medias, and machine learning or pattern recognition methods as well as generative models are important topics.

Medical image recognition and generation

Realistic Tumors in Random Locations
 (GAN) Generate
 Synthetic Images for Data Augmentation
 Original Brain MR Images
 Generate (Conditional GAN)
 Synthetic Images for Physician Training
 Realistic Tumors with Desired Size/Location by Adding Conditioning
 T1 T2 FLAIR

4D image generation

Generic image recognition

Deep Learning and Machine Learning

To enhance availability of deep learning, we are making various improvements for fast computation, memory reduction and robust learning. In addition, we are also developing flexible neural models to integrate various modalities, not only images but also natural language and others.

CNN architectures and optimization methods

Conditions using Fisher weight map
 Patch descriptor
 Layer 1
 Layer 2
 Layer 3
 Layer 4
 Full connection (Sigmoid regression)
 OUTPUT

Parameter compression via quantization network

encoder decoder
 $\tilde{E}(w)$ h_w α_{1P}^i d_{1P}^i A_i^+ d_{1P}^i $E(C_w)$

Multi-modal deep learning

Image Encoder
 Answer Encoder
 Caption Encoder
 Question Decoder
 Bicycle
 "The man rides a bicycle."
 "The man rides a bicycle."
 "The blue and white dog."

Open-world Intelligent Systems

While modern AI systems based on machine learning have become able to achieve high recognition performance for given concepts, they are hopeless when they face unknown concepts in the real world. To adaptively acquire new knowledge in the open world, we are developing many techniques such as knowledge transfer, object discovery, and retrieval-augmented generation.

Novel object captioning

Visual features
 Customized Q-Former
 Large Language Model
 Object name features
 Access to external Visual-Name Memory
 Key: Image embedding
 Value: Object name
 "Photos: Mouse - Mouse - Internet"

Transfer learning

Our method
 connected component decomposition
 matching
 (1) (2) (3) (4)

Object discovery and extraction

Source
 WEB
 Recognition
 Target

Natural Language Processing

One of the keys to realize computers being able to understand natural language is how to implement world knowledge on them. To this end, we believe it is important to employ not only linguistic data but broader multimodal information. Particularly, we are trying to establish a frontier spanning language and vision toward AIs with deep understanding of the world.

Neural machine translation

decoder states
 h_{t-1} h_t

LLM-based dialog agents

History H
 H_A H_U

Agent Persona P_A
 "I love cats."
 "I live in city."
 Gender: female
 Age: 18

User Persona P_U
 "My favorite food is ramen."
 Gender: male
 Age: 20

Context C
 Query Q

Response R

Agent A
 User U
 on the training set
 annotation

Visual storytelling

Concepts: 1 day winter cold 2 spot 3 bird
 4 water fish 5 lake

Our
 A cold winter day at the lake. [male] spotted an animal on the lake and thought that it was a strange bird he could spot. The bird seemed peaceful, and seemed to be enjoying the cold. It then tried to fish in the water. [male] kept a close eye on the bird, but had to keep his distance from the lake.

Ryota Shioya's Group

shioya@ci.i.u-tokyo.ac.jp

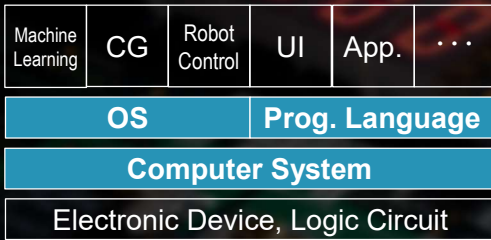

Our group's mission is to improve the performance, energy efficiency, and security of computer systems. We are conducting research on a wide range of topics, including computer hardware, programming languages, operating systems, and information security.

- Our research interests are in computer hardware and system software. We typically conduct research that includes both sides, such as good hardware that considers software properties, or good software that considers hardware properties.
- We welcome students who are interested in computer hardware, the foundation layers of software (language processing systems and operating systems), and information security.

Energy-efficient Hybrid CPU

We are conducting research on an energy-efficient hybrid CPU that combines different CPUs specialized to various situations.

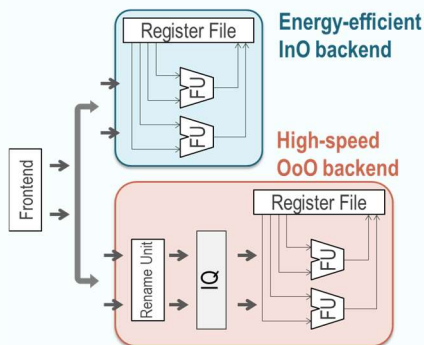

Dynamic Information Tracking for Security

We are conducting research on secure computer systems by tracking "information flow" and "the amount of information entropy" within a program. We are developing language runtimes for this purpose.

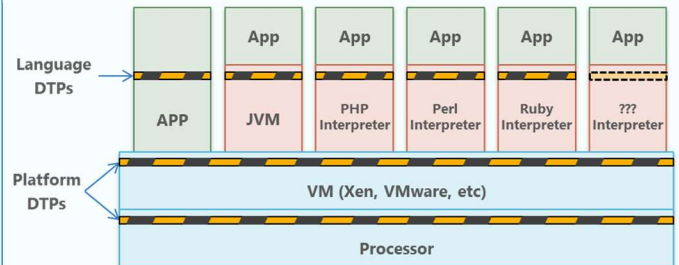

Advanced RISC-V CPU "RSD"

RISC-V is an open CPU standard, which has recently appeared. We are conducting research and development of advanced RISC-V compatible CPU "RSD" that introduced our research results.

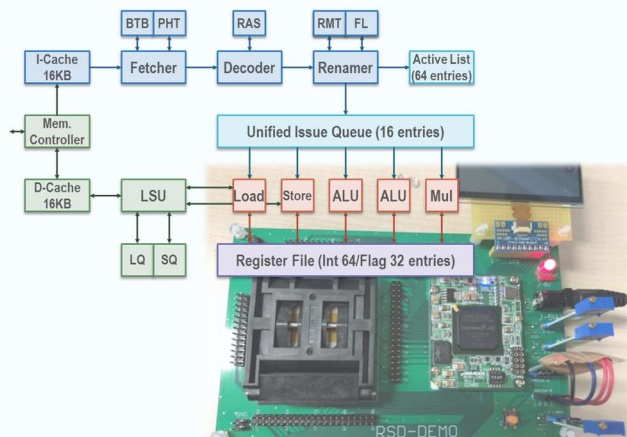

Other Research Topics

- Memory Compression for Scripting Languages
- Compiler/Binary Translator for our New CPU
- Fuzzing for Computer Hardware
- Hardware Accelerator for Self-driving Car
- CPU for Next-Generation Super Computer
- Energy Efficient GPU Architecture
- CPU Pipeline Visualization Tool

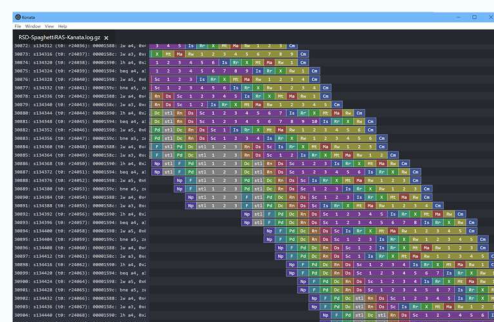

Name	Manabu Tsukada	Research Fields	Computer Network, Cyber physical systems
------	----------------	-----------------	--



Tsukada Laboratory was founded in 2019 as a part of Department of Creative Informatics. The laboratory focuses on **computer network** and **cyber-physical systems**, and have engaged in the fields of **transportation** and **live entertainment**. Transport research includes Intelligent transportation systems (ITS) and autonomous driving. Live entertainment research includes VR remote transmission of live music and platform for object-based media.

<http://tlab.hongo.wide.ad.jp/>

Transportation

– Network-assisted autonomous driving –



<http://gcl-muscat.jp/>

In ITS, research and development of autonomous driving have been actively carried out, but many of them are standalone mode autonomous driving that sensors and computers merely replace human perception, judgment, and operation. On the other hand, in the network-assisted autonomous driving, vehicles are connected by networks, and information on places which cannot be seen by automotive onboard sensors can be obtained, so further safety and efficiency can be achieved.

Keyword: Cooperative ITS, Wireless networking, Edge-cloud computing, Dynamic map, Ad-hoc networking, fifth-generation mobile communication system (5G), ISO/ETSI standards



Workshop with autonomous vehicle (Hongo, 2018)



With old colleagues at Vehicular conference (Nice, 2017)



Recording of Keio University's classic concert (Hiyoshi, 2016)



Demonstration in Interop Tokyo with industry partners (Makuhari, 2018)

Live entertainment

– Internet audio-visual media –

Software Defined Media

<http://sdm.wide.ad.jp/>

The objective of this study is to create an audio-visual software space that creates a global scale sense of unity over the Internet. Converting from large-size media and streaming services that are highly unidirectional, we will drastically transform the participation experience of remote audience in musical lives by supporting large-scale and distributed audience interactions with the venue.

Keyword: audio-visual media, immersive technologies, object-based audio, open data, VR/AR, Building Information Modeling (BIM)

Think globally from different points of view

During my undergraduate and master's course in Japan, I conducted three international research internships in Australia and France. Then, I worked in France for 6 years as a foreign researcher before coming to the University of Tokyo. Since 2013, I have been working at the University of Tokyo as a faculty member of the Global Creative reader (GCL) education program which is designed to educate leaders who will bring about social innovation driven by cooperation between different fields based on ICT. From my foreign experience and international collaboration, we consider diversity and different way of thinking is essential for social innovation. We are more than happy to help students to go abroad for their research works.

Research with academic-industry collaboration

The collaboration between academic and industry brings mutual benefits to both sectors. We established consortiums to discuss real issues in the research and business domain. Also, we conduct demonstration experiments, deployments of research achievements, and business trials.

Interactive Graphics & Engineering Group

<http://www.nobuyuki-umetani.com/>

Our group is working on computational fabrication, physics-based animation, digital contents creation. Computational prototyping machine such as 3D printers are widely available but it is still difficult for the novice users to design functional objects. Using physics simulation and machine learning techniques, we aim to achieve an interactive interface to facilitate the user's creative design. We welcome students how have interest in computer graphics or computational physics to develop new technologies together!

Machine learning on 3D geometry using autoencoder network

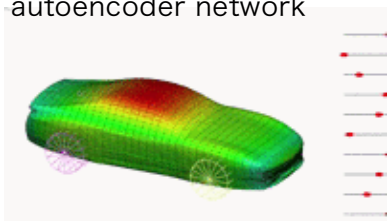

Design of wind-instruments using resonance simulation

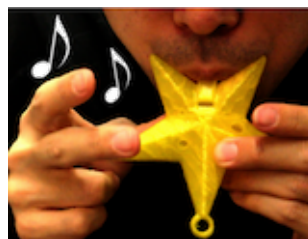

Robust simulation of flexible rods

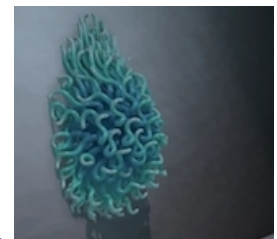

Machine learning aerodynamics

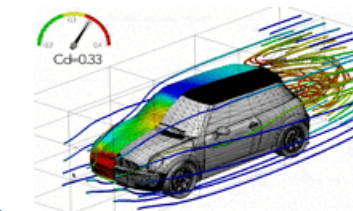

Interactive clothing patten design system

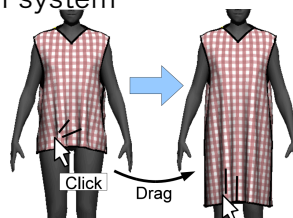

Detection of structural weakness

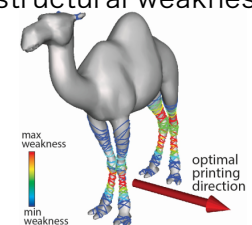

Code of conduct:

Pursuit your own interest

- We encourage each student to set up his/her own research subject through extensive literature survey. This is an essential skill to become an independent researcher.

Research communication skill

- We practice scientific writing and presentation a lot through paper submission and practice talk. Your awesome research worth nothing if the audience cannot understand it.

Applied math and programming

- Techniques in computer graphics can solve many practical problems. We put emphasis on math and programming skills to acquire these techniques and apply them for new problems.

Our group encourage international collaboration, joint collaboration with industry, and cross-disciplinary research. There are many opportunities in Japan as the graphics and manufacturing industries a strong (e.g., game and car). Highly motivated and skilled students are always welcome.

Tomoharu Ugawa Programming Languages, Garbage Collection, Implementation

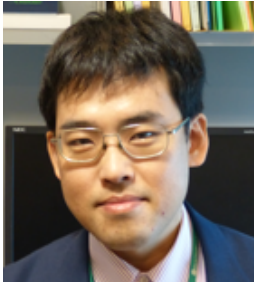

Almost every aspect of our lives today depends on computer systems. Every system depends on the programming languages it is written in. Our research area is software that is used to execute programs written in programming languages. Such software includes compilers and managed runtimes, which are also known as virtual machines.

How can we construct compilers and managed runtimes so that programs can be executed efficiently? How can we construct them in systems dealing with big data? How about in embedded systems? How can we construct them to utilize emerging accelerators? How can we implement new features of programming languages? We are exploring answers to those questions by implementing prototypes of compilers and managed runtimes.

We welcome students who like programming, algorithms, or engaging with complex systems.

<https://tugawa.github.io/index-e.html>

Project 1) Java with Persistent Data

Big-data applications desire high-performance persistent storage systems. We developed the Java system whose data and state (= variable) are preserved across power losses, by exploiting new Non-Volatile Memory (NVM) technologies, which can preserve memory contents without power.

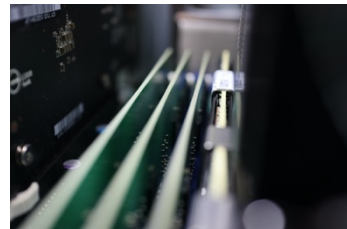

Project 2) A Tailor-Made JavaScript Virtual Machine for Embedded Systems



JavaScript is a widely-used programming language in browsers. Its execution needs a managed runtime called a JavaScript engine, which requires a lot of memory. We developed software that generates compact JavaScript engines that are customized to individual applications, and enabled JavaScript programs to

run in systems with small memory, such as IoT devices.

Project 3) Programming Framework for Processing-in-memory (PIM)

In the area of hardware, accelerators based on the PIM approach, which has a lot of processors in memory chips, are excessively studied. We are developing a framework that helps the development of software for such accelerators.

Concurrent Faculty Advisors who belong to other departments

name	Yusuke Miyao	Research Fields	Natural Language Processing, Computational Linguistics
<p>Our group conducts research in the field of natural language processing and computational linguistics. Humans communicate, understand information, and behave using natural language. Our goal is to clarify how this works by making full use of mathematical models and linguistic theories. Specifically, our research is focused on the following areas.</p> <ul style="list-style-type: none"> - Syntactic and semantic analysis, semantic inference: computing the structure and meaning of sentences in natural language. - Grounding: connecting the meaning of natural language with real-world data such as images and numerical data. - Dialogue systems: building computer systems that use natural language to exchange information. 			

name	Tsuyoshi Takagi	Research Fields	Mathematical Cryptography, Applied Cryptography
<p>We investigate the theory and practice of cryptography which underpins the security of our information society.</p> <p>(1)Mathematical Cryptography: We study post-quantum cryptography based on the mathematical problems (such as coding theory, lattice theory, multivariate polynomials, graph theory, etc), which are computationally intractable even in the era of quantum computing.</p> <p>(2)Applied Cryptography: We are engaged in the development of new efficient cryptographic algorithms and implementation secure against physical attacks, which can be used in our life, for example, copyright protection, electronic voting, cryptocurrency, and so on.</p>			

name	Kenji Kawashima	Research Fields	Medical Systems, Human-machine Systems, Robotics, Fluid Measurement and Control
<p>We analyze advanced biomedical measurement and control systems through a comprehensive approach to study on innovative medicals systems and human-machine systems.</p> <ul style="list-style-type: none"> - Autonomous Control of Surgical Robot: Study on a partially autonomous control method for a surgical robot by multimodal learning using internal sensor information of the robot and medical image information from a laparoscope. - System Control using Physical Reservoir Computing: Study on a method of using pneumatically-driven wearable assistive device to estimate the real-time state of the wearer through physical reservoir computing and use the estimates to control the device. 			

name	Kenjiro Taura	Research Fields	Parallel and distributed computing, programming languages, big data processing, high-performance computing, and their applications
<p>(Visit our homepage at https://tinyurl.com/taulab) Central topics of Taura group are software to deliver high-performance computing to everyone and high-performance applications. A pillar is designing programmer-friendly programming languages or libraries and their high-performance implementations with SIMD, multicores, GPUs, and supercomputers. The challenge is to attain both productivity and performance on complex hardware. They include domain-specific systems for machine learning, pattern extractions and N-body problems, general-purpose systems for load balancing and distributed shared memory and libraries for special-purpose hardware such as digital annealer (digital implementation of quantum annealer). Another pillar is big data processing and its applications. They include mining of company home pages for finding good business succession and analysis of electronic medical records for reducing medical accidents, around which we are seeking good synergies with research on machine learning frameworks and/or big data processing.</p>			

name	Tatsuya Harada	Research Fields	Computer Vision, Machine Learning, Real-world Intelligent Information Processing
<p>Our laboratory focuses on machine intelligence. Our goal is to invent hyper-intelligent systems by combining useful but infinite information in the physical space with a huge amount of data and powerful computational resources in the cyberspace. To tackle this challenging problem, we utilize all resources in the area of computer science including machine learning, computer vision, natural language processing and robotics.</p>			

name	Masaki Ito	Research Fields	Traffic Informatics, Cyber-physical Systems, Intelligent Transport Systems (ITS), Human-computer Interaction
<p>Ito Laboratory at the Social ICT Research Center conducts research to create advanced mobility systems through information technology. We are conducting practical research including traffic sensing, optimization of traffic signals, simulation of human and vehicle traffic, large-scale spatio-temporal data processing platforms, big data analysis of various traffic data, optimization of bus schedules and routes, and behavior change technology of people and vehicles. We welcome students who are interested in social issues such as urban planning and management of depopulated areas, students who are (or have been) interested in railroads, buses, automobiles, and other vehicles, and students who wish to conduct practical research using real data and real fields in collaboration with companies and local governments.</p>			

Department-specific Conditions on Submitted Documents

For other conditions on submitted documents common to all the departments, check the Admission Guide of the Graduate School.

List of Department-Specific Documents:

	Summer Examination		Winter Examination	
	Documents to be Submitted	Who to Submit	Documents to be Submitted	Who to Submit
Master's Program	Research Plan (2 pages in A4-size)	All Applicants	Research Plan (2 pages in A4-size)	All Applicants
Doctoral Program	Research Plan (6 pages in A4-size)	All Applicants	Research Plan (6 pages in A4-size)	All Applicants
Doctoral Program <Special Selection for Professionals>	Research Plan (6 pages in A4-size)	All Applicants	Research Plan (6 pages in A4-size)	All Applicants
	Major achievement during employment (no more than 2 pages in A4-size)	All Applicants	Major achievement during employment (no more than 2 pages in A4-size)	All Applicants

Department-specific Conditions on TOEFL Scores:

	Summer Examination	Winter Examination
Master's Program	All Applicants	All Applicants
Doctoral Program	All applicants except those who have completed (or are expected to complete) a master's program in the Graduate School of Information Science and Technology, the University of Tokyo	All applicants except those who have completed (or are expected to complete) a master's program in the Graduate School of Information Science and Technology, the University of Tokyo
Doctoral Program <Special Selection for Professionals>	All applicants except those who have completed a master's program in the Graduate School of Information Science and Technology, the University of Tokyo	All applicants except those who have completed a master's program in the Graduate School of Information Science and Technology, the University of Tokyo